

版本 REV.	日期 DATE	ECN NO.	变更内容 DESCRIPTION	制图 DRAWN

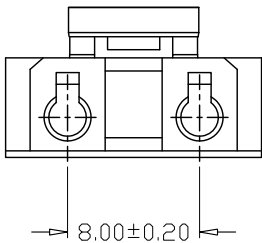
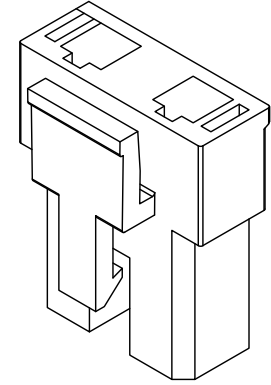
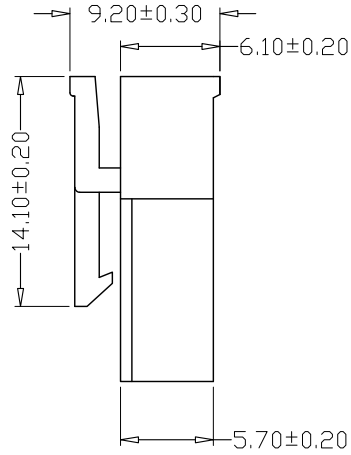
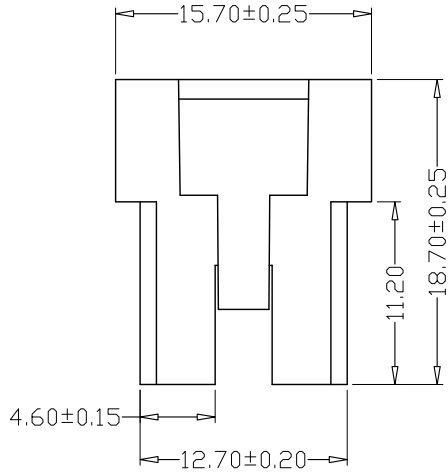
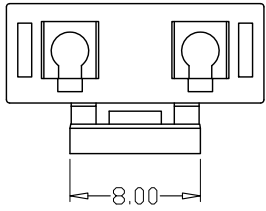

SPECIFICATIONS

- 1、Current Rating: 7A AC, DC
- 2、Voltage Rating: 250V AC, DC
- 3、Temperatuer Range: -25℃~+85℃
- 4、Contact Resistance: 20mΩ Max
- 5、Insulation Resistance: 1000MΩ Min
- 6、Withstanding Voltang: 1500V AC/minute
- 7、Material: Wafer PA66, UL94V-0

GENEAL TOLERANCE		制图 Mapping	张迎春 2022、12、21	料号 PART NO.	A80001-02Y	版本 REV.	A
X±0.25	X°±2°	审核 Audit	钱岳生 2022、12、21	品名 TITLE	80001孔座	页次 SHEET	1/1
.X±0.25	.X°±1°	核准 Approved	张名 2022、12、22	客户料号 CUTM. NO.			
.XXX±0.10	.XXX°±0.5°	单位 Units	mm	比例 SCALE			

乐清市宏一电子有限公司
 YueQing HongYi Electronics Co., Ltd

版本 REV.	日期 DATE	ECN NO.	变更内容 DESCRIPTION	制图 DRAWN

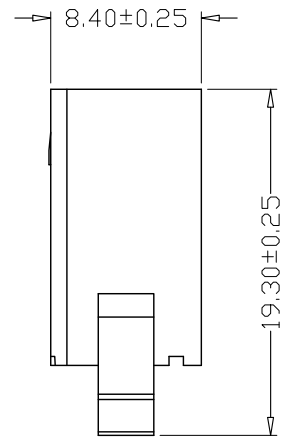
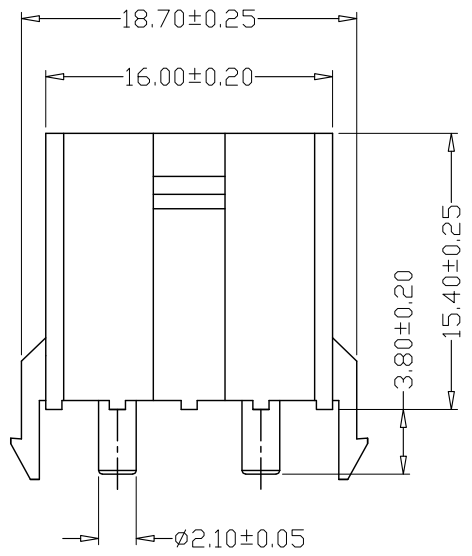
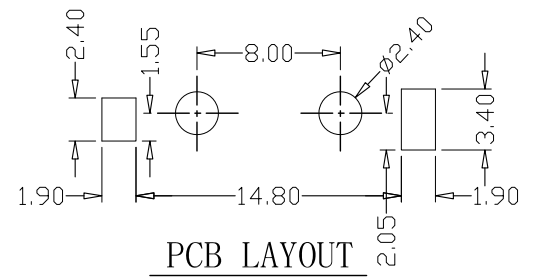
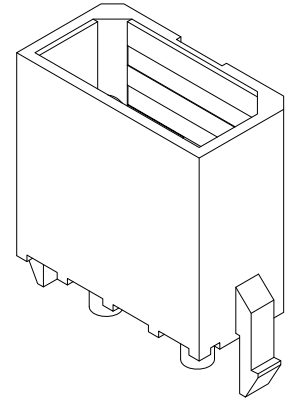
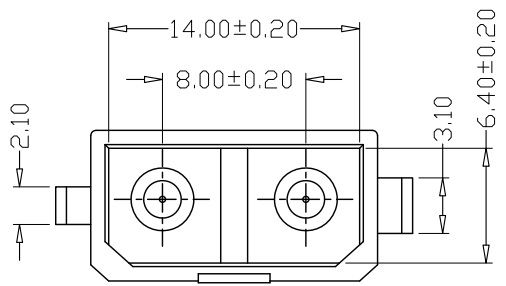

SPECIFICATIONS

- 1、Current Rating: 7A AC, DC
- 2、Voltage Rating: 250V AC, DC
- 3、Temperatuer Range: -25°C~+85°C
- 4、Contact Resistance: 20mΩ Max
- 5、Insulation Resistance: 1000MΩ Min
- 6、Withstanding Voltang: 1500V AC/minute
- 7、Material: Wafer PA46, UL94V-0
PIN Brass Tin-plated

GENREL TOLERANCE		制图 Mapping	张迎春 2022、12、21		料号 PART NO.	A80001-02A		版本 REV.	A	
X.±0.25	X.°±2°	审核 Audit	钱岳生 2022、12、21		品名 TITLE	80001直针 WAFER DIP TYPE		页次 SHEET	1/1	
.X±0.25	.X°±1°		张名 2022、12、22		客户料号 CUTM. NO.					
.XX±0.15	.XX°±0.5°	核准 Approved			乐清市宏一电子有限公司 Yueqing HongYi Electronics Co., Ltd					
.XXX±0.10	.XXX°±0.5°	单位 Units	mm	比例 SCALE						